

## Hydraulic Tipper Type THD

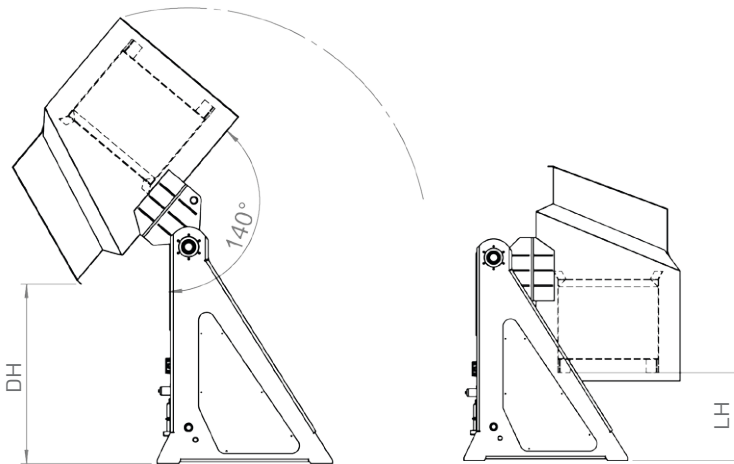

### CONTAINER SIZE

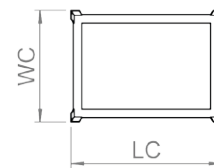
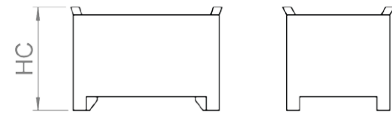

TIP OVER LC AXIS

DH: Discharge Height  
LH: Loading Height

HC: Height Container  
WC: Width Container  
LC: Length Container

### Fencing options

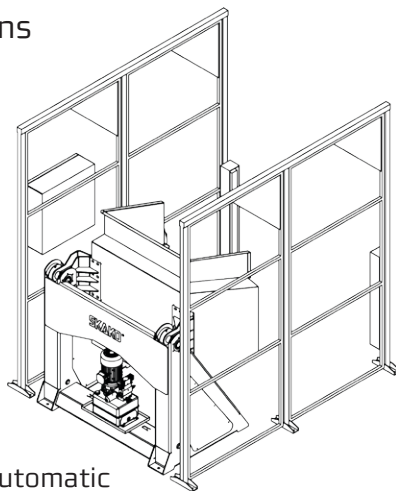

Automatic

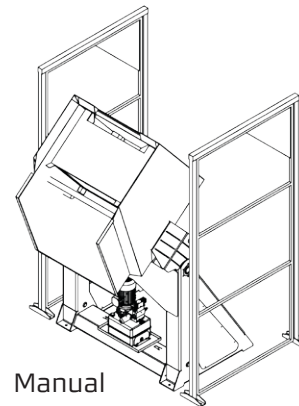

Manual

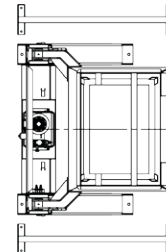
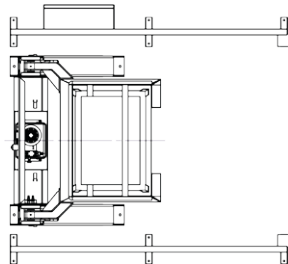

TYPE	MAX. LOAD CAPACITY (KG)	MAX CONTAINER SIZE LCxWCxHC (mm)
THD100	1000	1240 x 1000 x 1000
THD200	2000	1240 x 1000 x 1000
THD300	3000	1240 x 1000 x 1000

SKAKO VIBRATION retains all rights to change or improve the above specifications without notice.

05-01-2017

Please contact us for further information regarding exact dimensions and installations.