

Open Vibratory Feeder Type **FCE-3NL** with Electromagnetic Vibrator

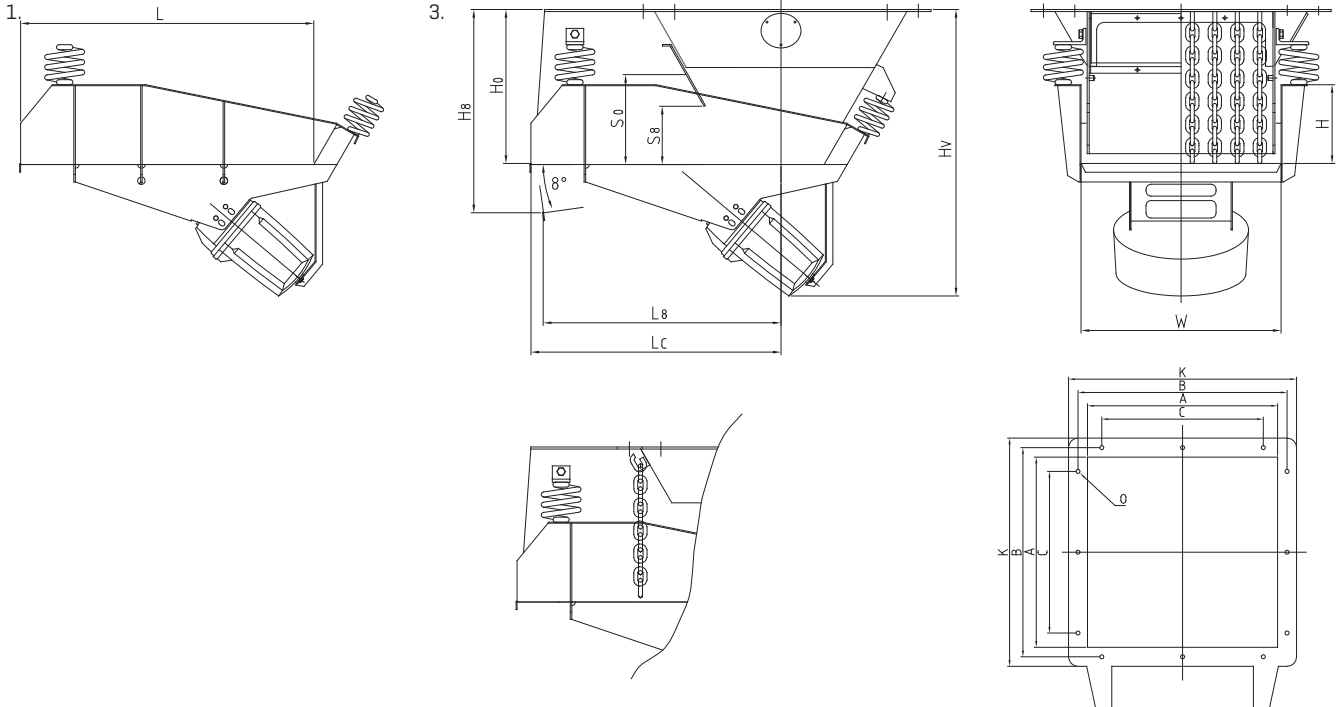

Feeder Size W/L ₀	Capacity m ³ /h 2)				Dimensions trough Profile (mm)			Vibrator Type 1)	Weight kg Excl. wear liner										Diameter (O)	Quantity (Q)		
	0°	0° 4)	8°	8° 4)	Width (W)	Height (H)	Wear Lining		1	3	L _c	H ₀	H _v	H ₈	S ₀ 4)	S ₈ 4)	A	B			C	K
020/0025	6	4	10	5	200	80	3	2D	15	20	250	170	395	220	80	115	250	290	210	330	11	8
020/0050	10	6	10	6	200	80	3	4D	20	25	500	170	440	260	80	115	250	290	210	330	11	8
028/0036	15	10	25	15	280	112	3	4D	20	30	360	235	465	300	110	150	360	400	330	450	14	8
028/0071	15	10	25	20	280	112	3	8D	45	55	710	230	540	350	110	150	360	400	330	450	14	8
040/0050	40	25	60	40	400	160	3	8D	45	80	500	335	635	430	170	220	500	580	450	650	18	8
040/0100	35	25	60	40	400	160	3	20D	95	130	1000	360	745	510	170	220	500	580	450	650	18	8
056/0071	95	60	150	90	560	225	4	20D	90	170	710	485	860	620	300	380	710	800	610	870	22	8
056/0125	120	100	180	145	560	225	4	50D	195	285	1250	460	1015	680	300	380	710	800	610	870	22	8
080/0100	175	70	320	130	800	315	5	50D	225	445	1000	650	1150	850	365	475	1000	1100	2x425	1200	22	12
080/0160	250	175	370	280	800	315	5	100D	410	665	1600	650	1310	930	365	475	1000	1100	2x425	1200	22	12
100/0125	250	165	500	270	1000	400	5	100D	460	870	1250	720	1400	955	440	600	1250	1400	2x525	1490	27	12
100/0200	270	180	350	230	1000	400	5	200D	850	1315	2000	720	1520	1070	440	600	1250	1400	2x525	1490	27	12
125/0160	350	200	450	250	1250	500	6	200D	910	1750	1600	1085	1890	1385	620	790	1600	1750	2x650	1900	27	12

1) See appropriate data sheets for vibrators and controllers.

2) The capacities stated are indicative for naturally moist sand 0-3 mm. Be aware that the capacities are stated in m³/h.

3) By replacing the trough gate with a chain curtain the opening is enlarged by approx. 50%.

4) Capacity with wear liner.

Please contact us for further information regarding exact dimensions and installations.
SKAKO Vibration retains all rights to change the above specifications without notice.

Open Vibratory Feeder Type **FCE-3NL** with Electromagnetic Vibrator

Feeder capacity can be regulated in 3 ways:

By declining the vibratory trough
Depending on the material, and on the optional trough lining, capacity is increased by approximately 30% by an 8° decline.

By adjusting the trough gate
Adjusting the trough gate allows a continuously variable regulation of the depth of material on the vibratory trough.

By means of the control
By means of the control, it is possible to achieve an infinite variation from 0% to 100% of the preset capacity.

Feeder size is chosen on the basis of:

Primarily, capacity in cubic metres per hour (m³/h)

Bulk densities in the range 0,3-5t/m³ have an insignificant influence on the capacity of feeders with electromagnetic vibrators.

Secondarily, particle size and material characteristics

Normally the indicated capacities are achievable when particle sizes are no larger than 1/10th of the trough width.

The feeders are able to handle considerably coarser materials, but with reduced capacity.

To avoid jamming, materials containing lump sizes larger than 1/3rd of the maximum gate opening, should only be handled in larger feeders.

Feeder Design:

All standard feeder sizes are available in a short version; the smaller sizes are also available in a long version for materials with a low slope angle.

A horizontal trough gives the following minimum slope angles at maximum and minimum gate openings:

Short feeders: approximately 30° and 15°, respectively.

Long feeders: approximately 15° and 7°, respectively.

Vibratory troughs may be lined with e.g rubber, PEHD, PUR, steel etc. The type of liner is selected according to the nature of the material to be handled [e.g sticky, corrosive or very abrasive].

Feeders with no wear lining are appropriate for proportioning from e.g rarely emptied silos. The material may be slightly to moderately abrasive, e.g vegetables, gravel and sand.

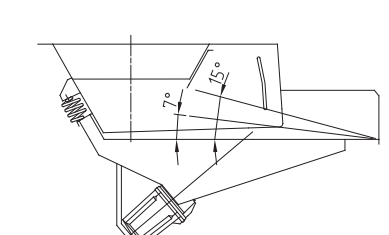
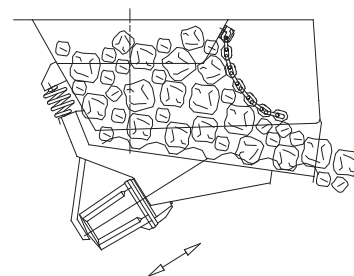
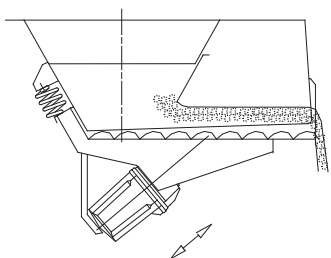
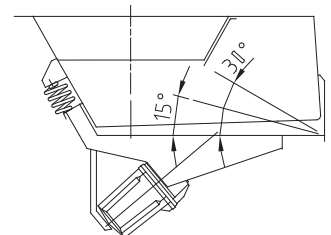
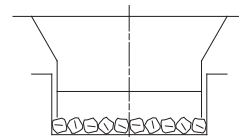
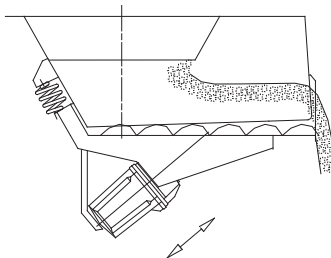
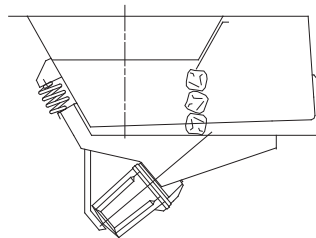
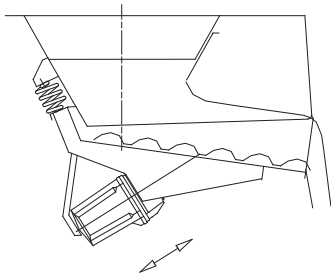

Please contact us for further information regarding exact dimensions and installations.
SKAKO Vibration retains all rights to change the above specifications without notice.